

1/4

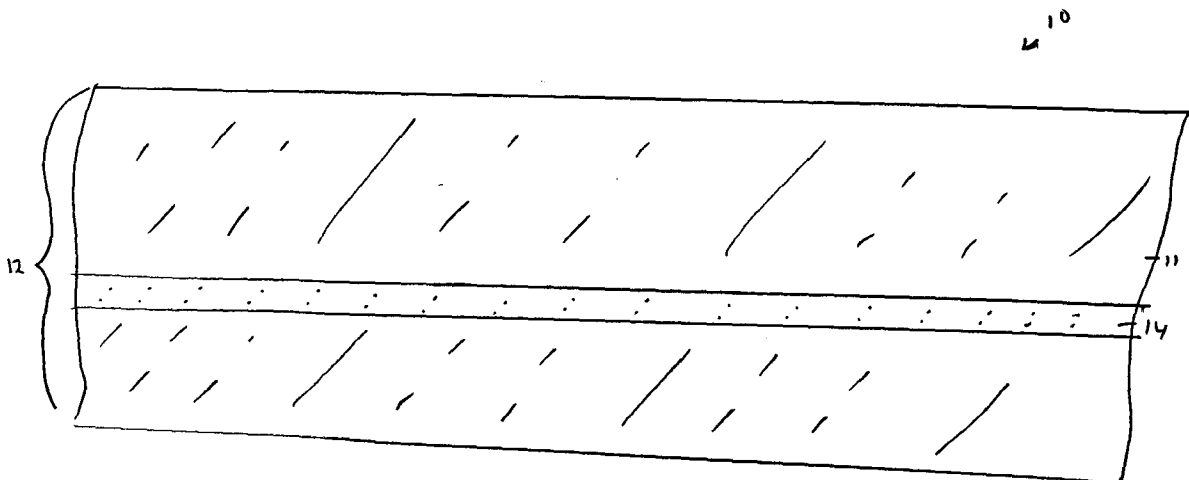

FIG. 1A

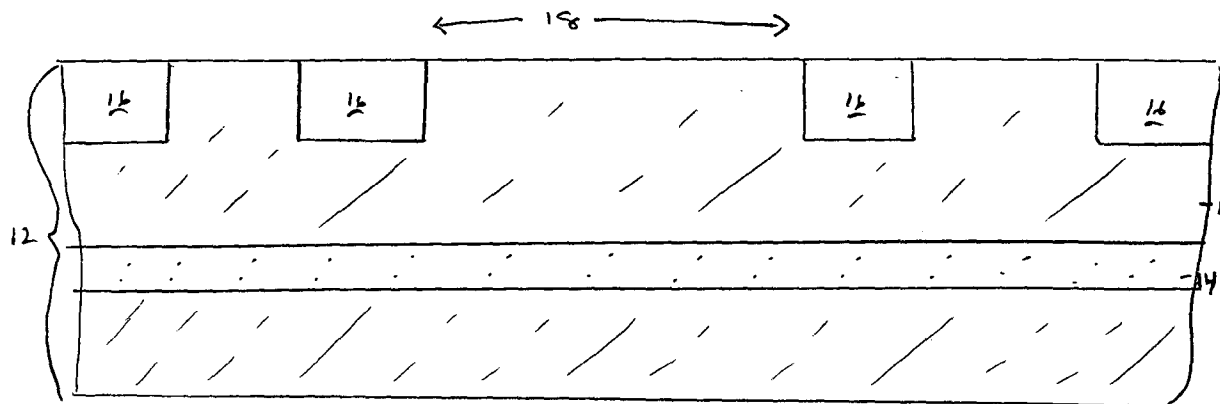

FIG. 1B

2/4

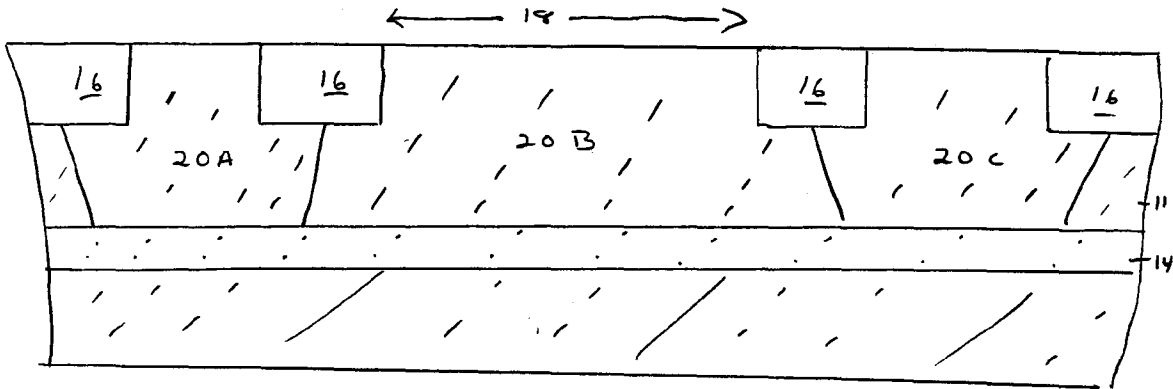

FIG. 1C

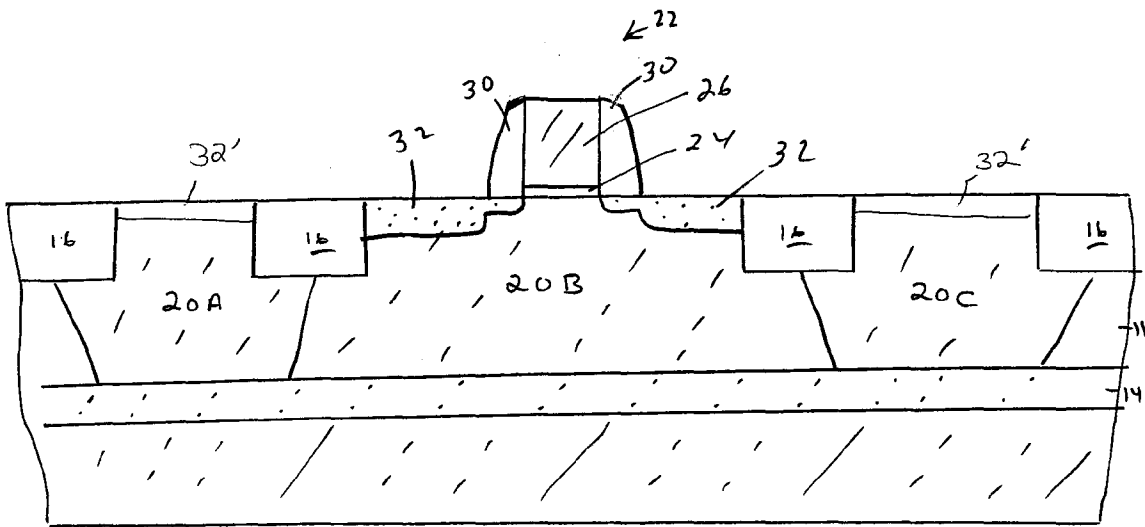

FIG. 1D

3/4

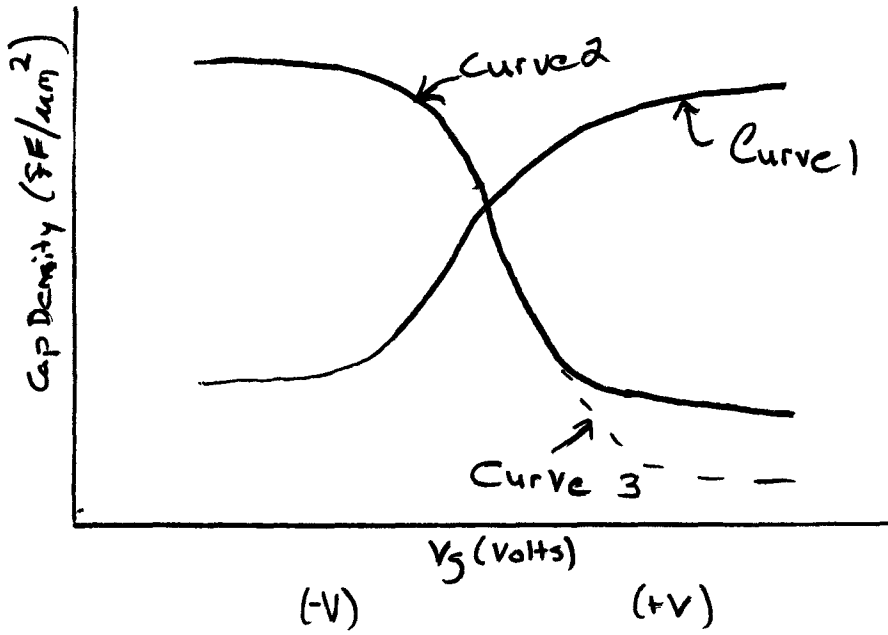

FIG. 2

4/4

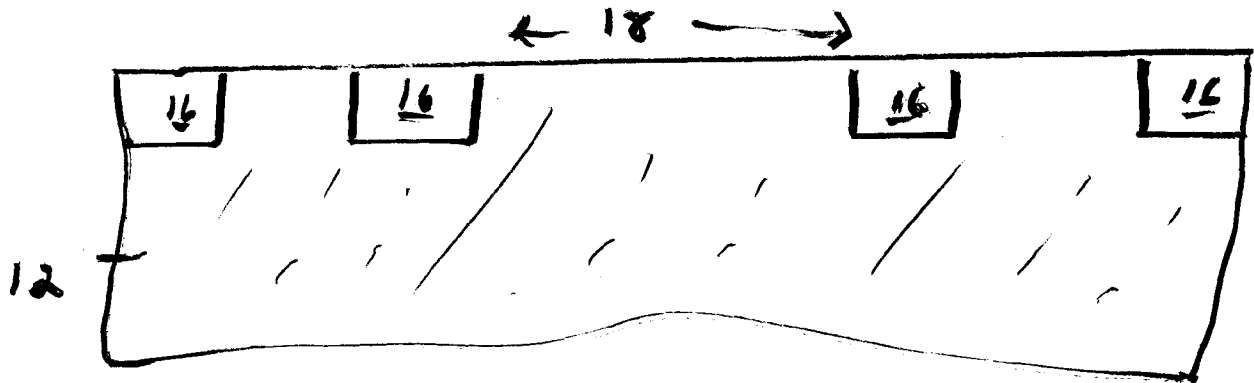

FIG. 3A

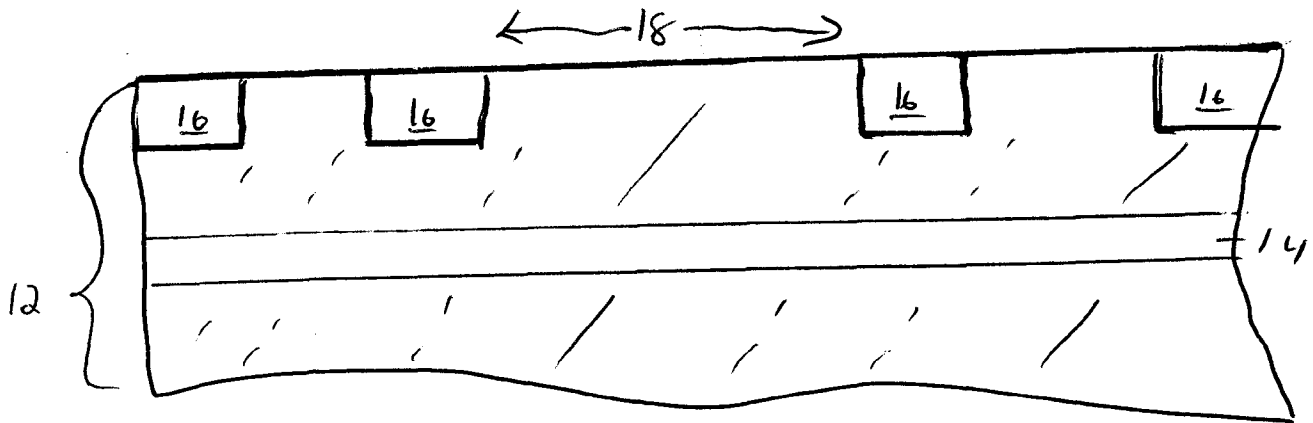

FIG. 3B

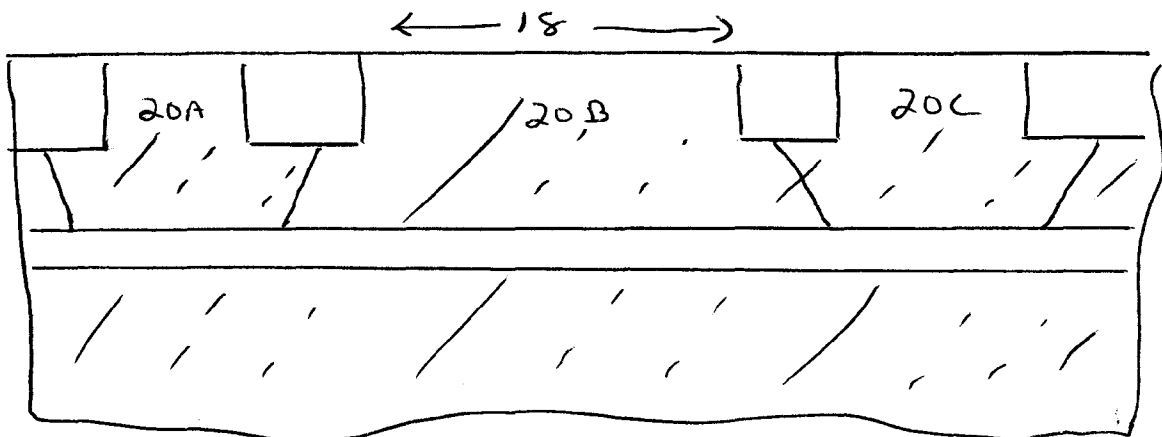

FIG. 3C

